

SPECIFICATION SHEET : IH2-UNV-270-T8

This Is An Original Product From Fulham Co., Inc

Description : Universal Voltage, Auto Restart With Cold Starting Feature For Refrigeration Application/s.

This Ballast Will Operate Following Lamps.

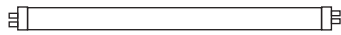

F58T8, F70T8

ELECTRICAL DATA (120V APPLICATION)

INPUT VOLT: 120V ± 10% , 50/60Hz						
LAMP WATTS/TYPE	F58T8	F70T8	F58T8	F70T8	-	-
LAMPS OPERATED	1	1	2	2		
INPUT POWER (W)	66	78	133	157		
LINE CURRENT	0.56	0.65	1.11	1.31		
POWER FACTOR						> 0.9
THD						< 10 %
CURRENT CREST FACTOR						< 1.7
EMI/RFI COMPLIANCE						FCC PART 18-A (Non-Consumer)
SOUND RATING						" A "
BALLAST TYPE						PROGRAMMED PREHEAT START
VOLTAGE TRANSIENTS						ANSI 62.41
INPUT/PROTECTION						FUSE
OUTPUT/PROTECTION						DEACTIVATED LAMP PROTECTION
MIN. OPERATING TEMP						-30 °C (-22 °F)
MAX. CASE TEMP						70 °C (158 °F)
TYPE						"CC"
APPROVALS/CLASS						UL /cUL LISTED, CLASS " P ", 1 OUTDOOR

MECHANICAL DATA

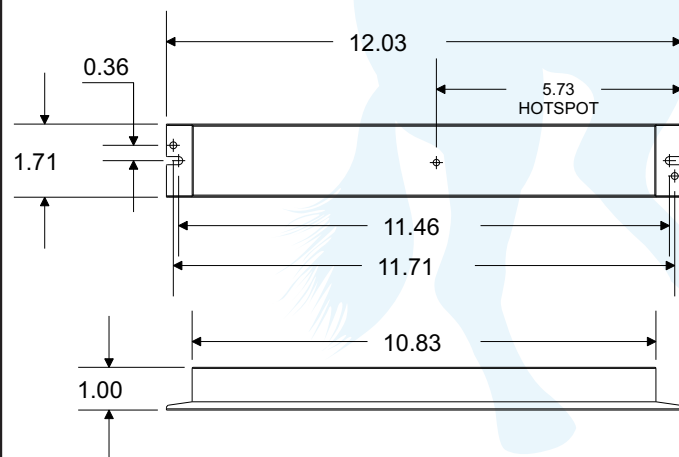

WIRING DIAGRAM

WIRES	WHT	BLK	GRN					
LENGTH-INCHES	7 ± 1"	7 ± 1"	7 ± 1"					
WIRES	ORG/WH	ORG	BRN	BRN	RED/WH	RED	BLU	BLU
LENGTH-INCHES	7 ± 1"	7 ± 1"	7 ± 1"	7 ± 1"	7 ± 1"	7 ± 1"	7 ± 1"	7 ± 1"

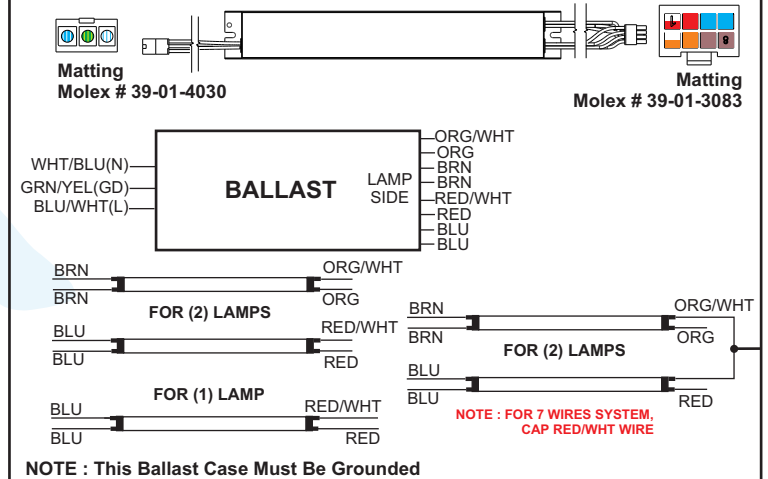

Fulham Co., Inc extends limited warranty only to the original purchaser or to the first user for the period of 3 years from the date of manufacture as indicated by the date code stamped on each product and when properly installed and under normal conditions of use. For additional warranty guide line, please refer to our Complete Product Catalog OR call Customer Service at 1-323-599-5000.

DUE TO A PROGRAM OF CONTINUOUS IMPROVEMENT, FULHAM Co., INC RESERVES THE RIGHT TO MAKE ANY VARIATION IN DESIGN OR CONSTRUCTION TO THE EQUIPMENT DESCRIBED.

Address : 12705 South Van Ness Ave., Hawthorne, CA 90250 Tel.: 1-323-599-5000, Fax.: 1-323-754-9060. Website: www.fulham.com 2006-142-1 rev C

SPECIFICATION SHEET : IH2-UNV-270-T8

This Is An Original Product From Fulham Co., Inc

Description : Universal Voltage, Auto Restart With Cold Starting Feature For Refrigeration Application/s.

This Ballast Will Operate Following Lamps.

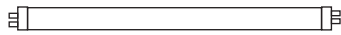

F58T8, F70T8

ELECTRICAL DATA (230V APPLICATION)

INPUT VOLT: 230V ± 10%, 50/60Hz						
LAMP WATTS/TYPE	F58T8	F70T8	F58T8	F70T8	-	-
LAMPS OPERATED	1	1	2	2		
INPUT POWER (W)	66	77	130	152		
LINE CURRENT	0.30	0.34	0.57	0.67		
POWER FACTOR						> 0.9
THD						< 10 %
CURRENT CREST FACTOR						< 1.7
EMI/RFI COMPLIANCE						FCC PART 18-A (Non-Consumer)
SOUND RATING						" A "
BALLAST TYPE						PROGRAMMED PREHEAT START
VOLTAGE TRANSIENTS						ANSI 62.41
INPUT/PROTECTION						FUSE
OUTPUT/PROTECTION						DEACTIVATED LAMP PROTECTION
MIN. OPERATING TEMP						-30 °C (-22 °F)
MAX. CASE TEMP						70 °C (158 °F)
TYPE						"CC"
APPROVALS/CLASS						UL /cUL LISTED, CLASS " P ", 1 OUTDOOR

MECHANICAL DATA

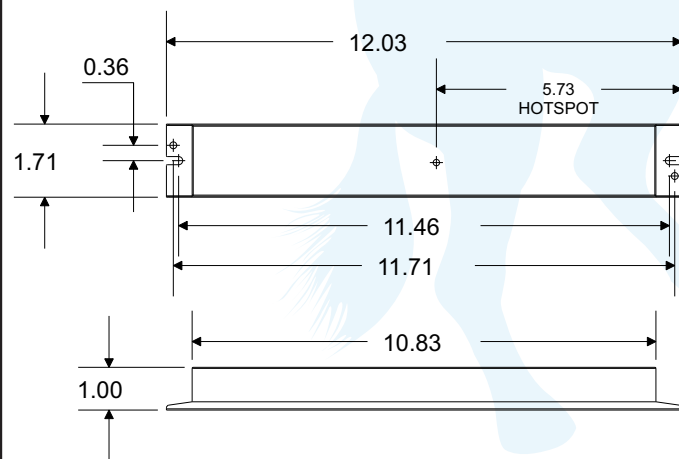

WIRING DIAGRAM

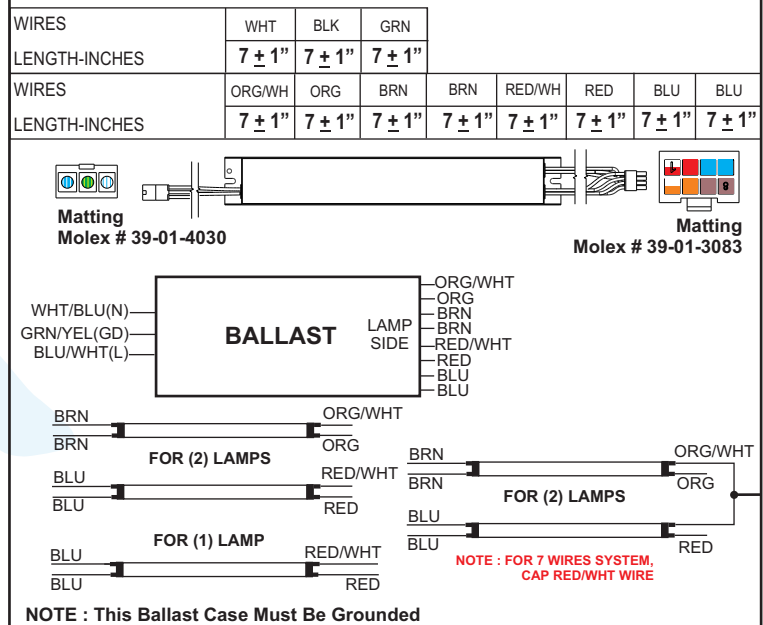

Fulham Co., Inc extends limited warranty only to the original purchaser or to the first user for the period of **3 years** from the date of manufacture as indicated by the date code stamped on each product and when properly installed and under normal conditions of use. For additional warranty guide line, please refer to our Complete Product Catalog OR call Customer Service at 1-323-599-5000.

DUE TO A PROGRAM OF CONTINUOUS IMPROVEMENT, FULHAM Co., INC RESERVES THE RIGHT TO MAKE ANY VARIATION IN DESIGN OR CONSTRUCTION TO THE EQUIPMENT DESCRIBED.

Address : 12705 South Van Ness Ave., Hawthorne, CA 90250 Tel.: 1-323-599-5000, Fax.: 1-323-754-9060. Website: www.fulham.com 2006-142-2 rev C

SPECIFICATION SHEET : IH2-UNV-270-T8

This Is An Original Product From Fulham Co., Inc

Description : Universal Voltage, Auto Restart With Cold Starting Feature For Refrigeration Application/s.

This Ballast Will Operate Following Lamps.

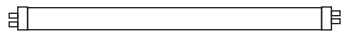

F58T8, F70T8

ELECTRICAL DATA (277V APPLICATION)

INPUT VOLT: 277V ± 10% , 50/60Hz						
LAMP WATTS/TYPE	F58T8	F70T8	F58T8	F70T8	-	-
LAMPS OPERATED	1	1	2	2		
INPUT POWER (W)	66	77	130	152		
LINE CURRENT	0.25	0.29	0.48	0.56		
POWER FACTOR						> 0.9
THD						< 10 %
CURRENT CREST FACTOR						< 1.7
EMI/RFI COMPLIANCE						FCC PART 18-A (Non-Consumer)
SOUND RATING						" A "
BALLAST TYPE						PROGRAMMED PREHEAT START
VOLTAGE TRANSIENTS						ANSI 62.41
INPUT/PROTECTION						FUSE
OUTPUT/PROTECTION						DEACTIVATED LAMP PROTECTION
MIN. OPERATING TEMP						-30 °C (-22 °F)
MAX. CASE TEMP						70 °C (158 °F)
TYPE						"CC"
APPROVALS/CLASS						UL /cUL LISTED, CLASS " P ", 1 OUTDOOR

MECHANICAL DATA

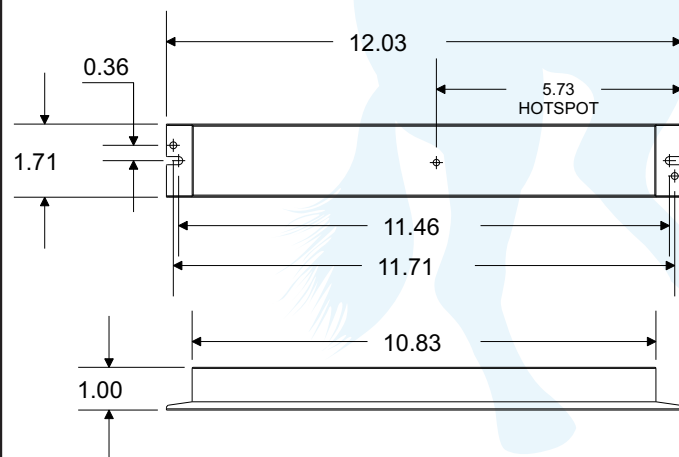

WIRING DIAGRAM

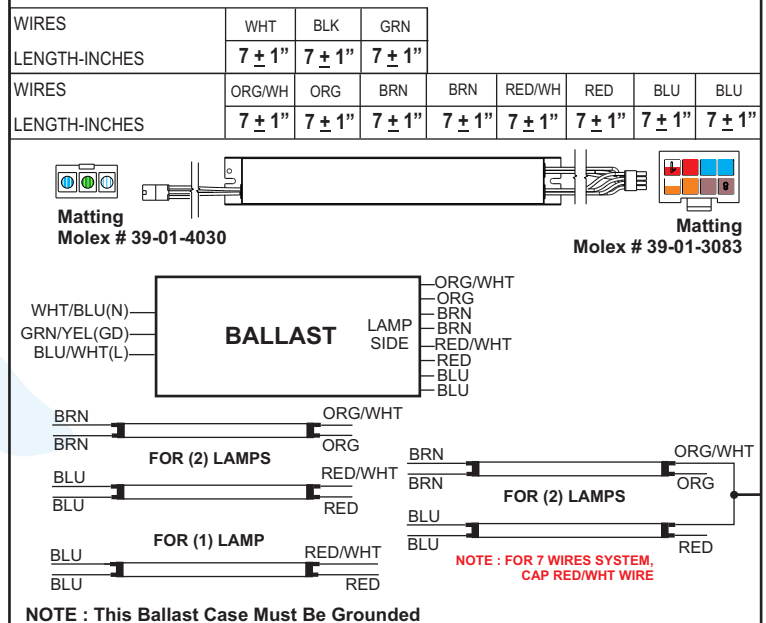

Fulham Co., Inc extends limited warranty only to the original purchaser or to the first user for the period of 3 years from the date of manufacture as indicated by the date code stamped on each product and when properly installed and under normal conditions of use. For additional warranty guide line, please refer to our Complete Product Catalog OR call Customer Service at 1-323-599-5000.

DUE TO A PROGRAM OF CONTINUOUS IMPROVEMENT, FULHAM Co., INC RESERVES THE RIGHT TO MAKE ANY VARIATION IN DESIGN OR CONSTRUCTION TO THE EQUIPMENT DESCRIBED.

Address : 12705 South Van Ness Ave., Hawthorne, CA 90250 Tel.: 1-323-599-5000, Fax.: 1-323-754-9060. Website: www.fulham.com 2006-142-3 rev C